

# 3000 GAL GREASE INTERCEPTOR

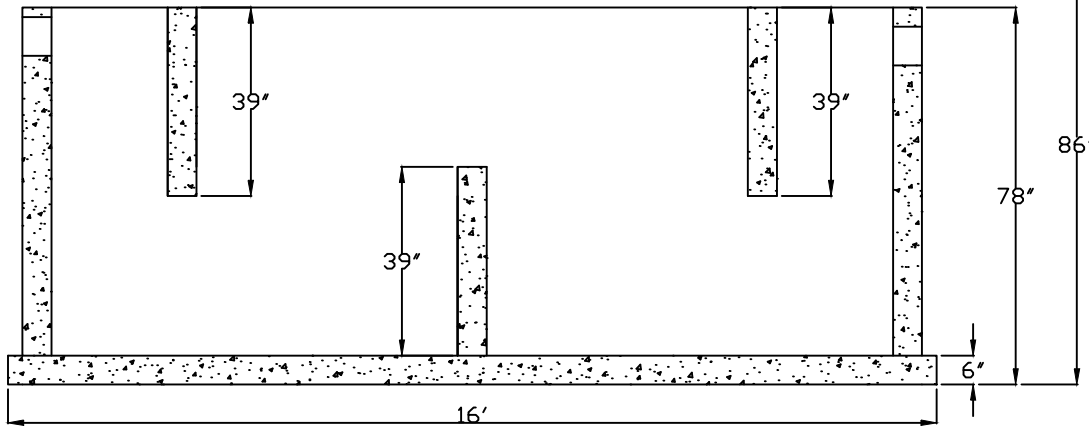
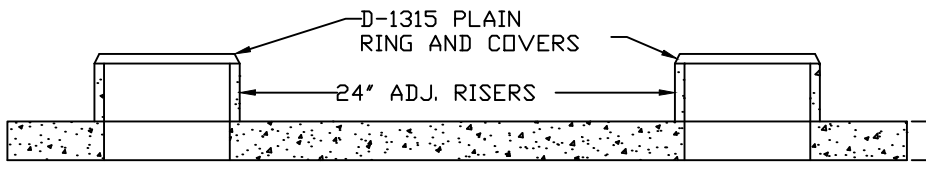
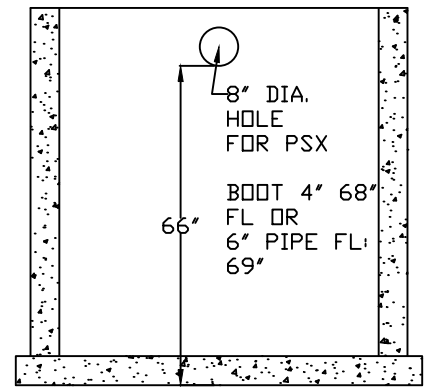
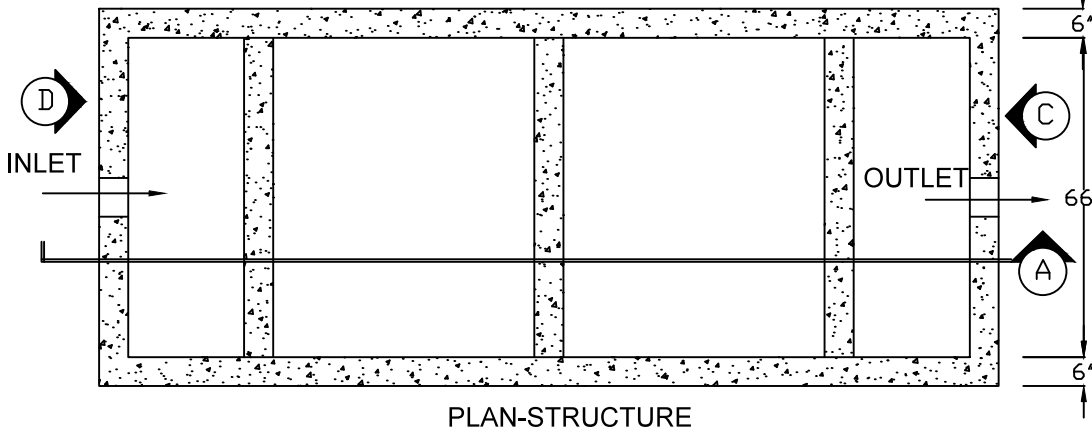
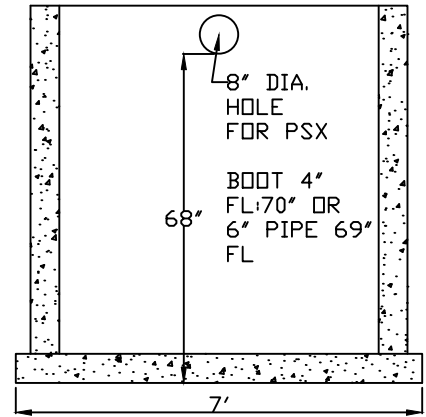
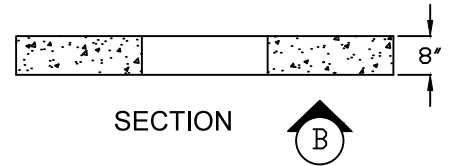
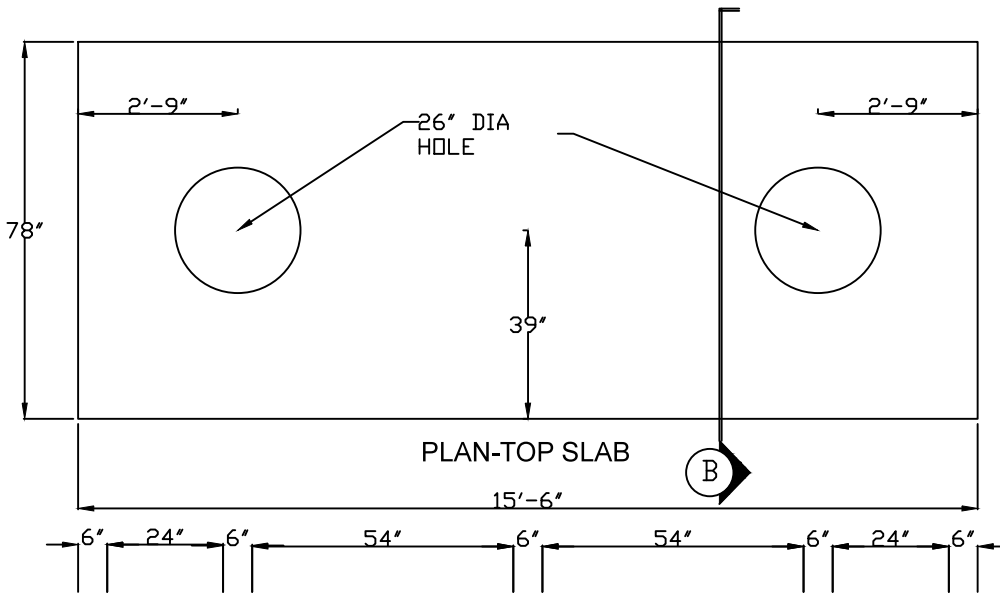

WT. TOP SLAB 9711#  
 WT. STRUCTURE 29679#

#4 @ 12" C/C EA. WAY WALLS  
 #5 @ 6" C/C EA. WAY TOP SLAB  
 #5 @ 12" C/C EA. WAY BOT SLAB